

ETTS

EAST TEXAS TRUCK SYSTEMS

Water Truck Parts Catalog ***2019***





2283 Montgomery Gardens
Tyler, TX 75708
(903) 531-9700

Prices Subject to Change

Basic Plumbing		
Part Description		Price
<p>101-323-GRV-AL-USA PREMIUM, Aluminum Inline Diaphragm Valve 3" grooved ends. Air operated. Normally open. 7 to 10psi to open. 176GPM</p>		<p>\$166.95</p>
<p>101-CAP-AL-USA PREMIUM, Aluminum replacement cap for 101-XXX-AL-USA</p>		<p>\$25.75</p>
<p>G101-500BPSI Rubber Diaphragm gasket for 101 Valve to 233wpsi</p>		<p>\$19.50</p>
<p>108-INLINE-VALVE-ATP NORMALY CLOSED, inline valve, air to open. 3' groove connections.</p>		<p>\$337.50</p>
<p>108-Diaphragm</p>		<p>\$13.00</p>
<p>108-REPAIR-I.KIT ball, poppet, spring, diaphragm, nuts, and washers</p>		<p>\$80.17</p>
<p>108-USA-NL PREMIUM, MADE IN USA, Integral Adjustable Spray Head Valve 3" Vic grooved, Normally closed, air to open. 525 GPM@80 PSI, WITH NO LOGO (UNLABLED)</p>		<p>\$275.00</p>



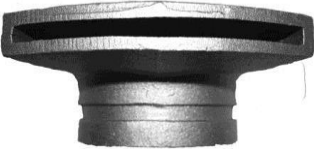

Prices Subject to Change

<p>108-DBSOEA Duckbill side spray assy. Includes: 108, 108-DB-1/4x4.5, GV-3-CP-R,QEV+</p>		<p>\$375.00</p>
<p>102 Elbow 3" grooved aluminum Note! 102 is a higher flow, longer Elbow than Standard Vic Style, allows for more adjustment with 103 Spray Head</p>		<p>\$38.50</p>
<p>103 Adjustable slip on Deflector Splash Head aluminum.</p>		<p>\$48.00</p>
<p>104 Spray Head Straight Outlet Vic Grooved aluminum.</p>		<p>\$28.87</p>
<p>111 3" Side spray head 1/4" x 5" Slot, Grooved Aluminum.</p>		<p>\$31.50</p>
<p>105 Foot Valve 3" hose barb aluminum works in shallow streams.</p>		<p>\$85.00</p>
<p>106 Spray Head Elbow Outlet 3" aluminum Grooved</p>		<p>\$31.50</p>
<p>110 3" Adjustable Fan spray nozzle, Grooved Aluminum (Adjustable)</p>		<p>\$85.00</p>







Prices Subject to Change

<p>109 Air Actuated Air Valve (90) for spray heads) Normally open air to close</p>		<p>\$270.00</p>
<p>109 Replacement parts</p>		<p>\$88.20</p>
<p>CRA-2-Valve-DI 2" inline valve FNPT Full Flow, Heavy Duty 200gpm Ductile Iron Body</p>		<p>\$236.25</p>
<p>CRA-2-Diaphragm-Kit</p>		<p>\$45.00</p>
<p>SPRAY-CAP slotted spray head</p>		<p>\$26.00</p>
<p>SPRAY CAP Slotted spray head with 3" threaded nipple</p>		<p>\$38.85</p>
<p>Grooved Steel 90s</p>		<p>3" Elbow \$16.57 4" Elbow \$26.25</p>
<p>Grooved Steel Ts</p>		<p>3" T \$22.50 4" T \$51.08 4" to 3" Reducer T \$73.00</p>

Prices Subject to Change

<p>Grooved KC Nipple</p>		<p>1" Nipple \$5.00 2" Nipple \$9.00 3" Nipple \$18.00 4" Nipple \$25.00 6" Nipple \$62.00</p>
<p>Steel Cap</p>		<p>3" Cap \$12.00</p>
<p>Victaulic Clamps</p>		<p>3" Clamp \$14.62 4" Clamp \$18.28 4" to 3" Reducer \$47.76 6" Clamp \$32.00</p>
<p>Diaphragm – Vic Clamps</p>		<p>3" Diaphragm \$8.00 4" Diaphragm \$11.00 4" to 3" Reducer \$18.00 6" Diaphragm \$17.00</p>
<p>Butterfly Valve</p>		<p>3" Valve \$90.00 4" Valve \$94.00</p>
<p>Super Vac Hose</p>		<p>2" Hose \$8.50/ft 3" Hose \$10.50/ft 4" Hose \$14.50/ft</p>

Prices Subject to Change

Pumps/PTOs		
<p>PUMP-CCW-GRV-RP-GR Berkely style pump, counterclockwise B66895, 4" x 3" grooved with SS shaft, rope packing, 112 lbs, 750GPM@2500GPM/60PSI</p>		<p>\$1,350.00</p>
<p>PUMP-CCW-GRV-MS-GR Berkely style pump, counterclockwise B68416 with MECHANICAL SEAL, 4" x 3" grooved with SS shaft, 112 lbs 750GPM@2500GPM/60PSI</p>		<p>\$1,500.00</p>
<p>PUMP-CW-GRV-RP-GR Berkeley style pump, clockwise B66899, 4" x 3" grooved with SS shaft, rope packing, 112 lbs, 750GPM@2500GPM/60PSI</p>		<p>\$1,350.00</p>
<p>PUMP-CW-GRV-MS-GR Berkeley style pump, clockwise B68417 with MECHANICAL SEAL, 4" x 3" grooved with SS shaft, 112 lbs 750GPM@2500GPM/60PSI</p>		<p>\$1,500.00</p>
<p>Berkley Pump</p>		<p>\$1,600</p>
<p>PUMP-BRACKET Pump bracket for mounting pump to truck frame</p>		<p>\$85.50</p>
<p>PTO's</p>		<p>Call for Price</p>

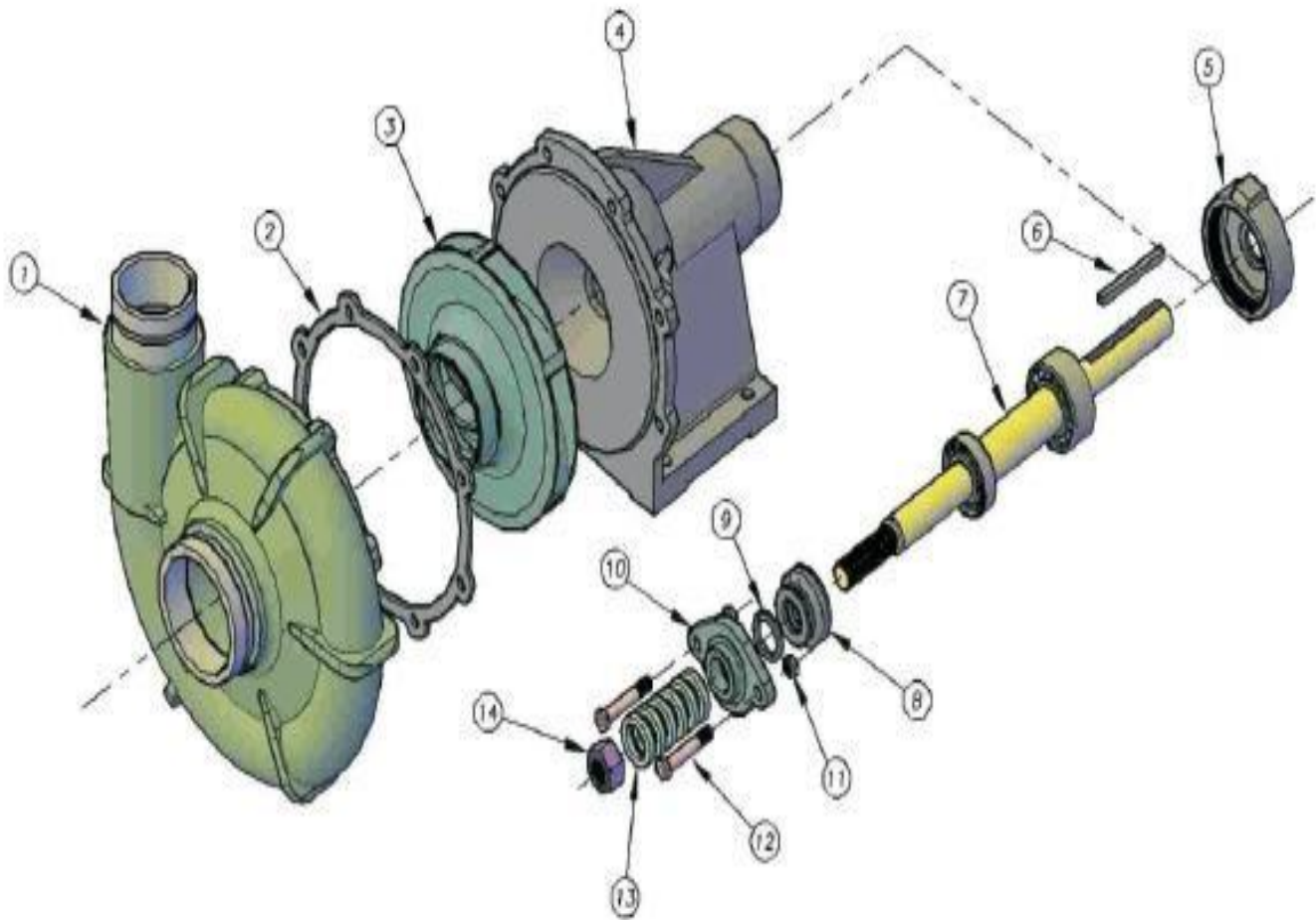

Pump Parts		
PUMP-VALUTE-CCW-GRV	#1	\$436.00
PUMP-GASKET	#2	\$30.00
PUMP-CCW-IMPELLER	#3	\$556.00
PUMP-3-BASE-#4	#4	\$665.00
PUMP-OUTER-BEARING-	#5	\$92.00
Pump-CCW-SHAFT-KIT	Includes # 6,7 and 14	\$475.00
PUMP-INNER-BEARINGCAP	#8	\$30.00
PUMP-SLINGER	#9	\$6.00
PUMP-PACKING-GLAND	#10	\$140.00
PUMP-PACKING-GLAND-	#11	\$4.00
PUMP-PACKING-GLAN-	#12	\$4.00
PUMP-PACKING-ROPE-KIT-B	#13	\$26.00
PUMP-PACKING-ROPE-KIT-M	Rope Packing for Monach NT3M9S	\$35.00
PUMP-SHAFT-NUT	#14	\$6.00

Prices Subject to Change

PUMP-MECH-SEAL-B	Mechanical Seal for Berkeley B3ZRM	\$174.00
PUMP-MECH-SEAL-M	Mechanical Seal for Monarch NT3M9S	\$255.00
PUMP-TO-HYD-ADT Hydraulic Adapter for the		\$600.00
Berkeley Pump PUMP-3-GRV-CI-PT-GR-WV	Pump without valute(can be attached to threaded valute)	\$1,200.00

Air Fittings/Valves			
AQ62-N-5/32		5/32 tube union	Call for Price
AQ62-N-2		1/8 tube union	Call for Price
AQ62-N-4		1/4 tube union	Call for Price
AQ68-N-5/32x0		5/32" tube x 0-unc-oring seal straight	Call for Price
AQ68-N-2X2		1/8" tube x 1/8" mpt straight	Call for Price
AQ68-N-4X2		1/4" tube x 1/8" mpt straight	Call for Price
AQ68-N-4X4		1/4" tube x 1/4" mpt seal straight	Call for Price
AQ69-NS-5/32X0		5/32" tube x 0-unc swivel mpt 90	Call for Price
AQ69-NS-2X2		1/4" tube x 1/8" swivel mpt 90	Call for Price
AQ69-NS-4X2		1/4" tube x 1/8" swivel mpt 90	Call for Price
AQ69-NS-4X4		1/4" tube x 1/4" swivel mpt 90	Call for Price
AQ71-NS-4X2		swivel male run tee 1/4 tube x 1/8mpt	Call for Price
AQ71-NS-4X4		swivel male run tee 1/4 tube x 1/4mpt	Call for Price
AQ72-NS-4X2		swivel male branch tee 1/4 tube x 1/8mpt	Call for Price
AQ72-NS-4X4		swivel male branch tee 1/4 tube x 1/4mpt	Call for Price
MW68-NO-2X2		1/8" tube x 1/8" mpt-oring seal straight	Call for Price
MW68-NO-5/32x0		5/32" tube x 0-unc-oring seal straight	Call for Price
MW68-NO-4X2		1/4" tube x 1/8" mpt-oring seal straight	Call for Price
MW68-NO-4X4		1/4" tube x 1/4" mpt-oring seal straight	Call for Price
MW69-NSO-5/32X0		5/32" tube x 0-unc swivel mpt-oring seal 90	Call for Price
MW69-NSO-4X2		1/4" tube x 1/8" swivel mpt-oring seal 90	Call for Price
MW69-NSO-4X4		1/4" tube x 1/4" swivel mpt-oring seal 90	Call for Price
AQ68-DOT-4X2		D.O.T. 1/4" tube x 1/8" mpt	Call for Price
AQ68-DOT-4X4		D.O.T. 1/4" tube x 1/4" mpt	Call for Price
AQ69-DOTS-4X2		D.O.T. 1/4" tube x 1/8" mpt	Call for Price
AQ69-DOTS-4X4		D.O.T. 1/4" tube x 1/4" mpt	Call for Price

Prices Subject to Change

<p>PT-1/8 Air Control Flipper valve OnOff Two position chrome plated steel handle.</p>		<p>\$20.00</p>
---	--	----------------

<p style="text-align: center;">Additional Parts</p>		
<p>ROJO-3GV-2.5FPT-12V This is a Electric Rotating Joint. 3" groove inlet and outlet with 2 1/2" NPT threads in both ends as well. It has a 12 volt motor, 250 psi, 10 to 340 degree adjustable rotation.</p>		<p>\$1000.00</p>
<p>ROJO-3GV-2.5FPT-24V This is a Electric Rotating Joint. 3" groove inlet and outlet with 2 1/2" NPT threads in both ends as well. It has a 24 volt motor, 250 psi, 10 to 340 degree adjustable rotation.</p>		<p>\$1000.00</p>
<p>ROJO-SWITCH-12V/24V Electric rocker switch for ROJO, 12 volt</p>		<p>Call for Price</p>
<p>ROJO-104-KIT</p>		<p>\$1,050.00</p>
<p>ROJO-106-KIT</p>		<p>\$1,050.00</p>

Prices Subject to Change

<p>ROJO-111-KIT</p>		<p>\$1,065.00</p>
<p>NITRO HD WATER CANNON Stainless steel thrust rods/bearings, sealed motors, 750GPM flow rate, environmentally sealed nozzle capable of 90 degree fog or straight stream flow pattern, in-cab joystick controls.</p>		<p>Call for Price</p>
<p>HR-HDCR-11/2x50-ST Hose Reel hand crank handles 50' of 1 1/2 hose. Heavy duty steel frame. Beveled gear for ease of Cranking! Greased bearings!</p>		<p>\$775.00</p>
<p>HR-HDCR-W/11/2X50'-BK Above reel with 50' of 1 1/2" 250wpsi black water/air hose cpld Mpt x Mpt and installed on reel.</p>		<p>\$850.00</p>
<p>HR-HDCR-W/1X100'-BK Above reel with 100' of 1" 300wpsi black water/air hose cpld Mpt x Mpt & installed on reel.</p>		<p>\$900.00</p>
<p>HR-HDCR-Kit-11/2x50-BK. Ready to install reel kit w/50' of 1 1/2" hose (installed on reel), Nozzle, 5' of feed hose, 2-mpt hose barbs & clamps, tank nipple, Ball Valve & St Elbow.</p>		<p>\$850.00</p>
<p>A431171EH1LC ELECTRIC HOSE REEL, 1 1/2" X 50, HEAVY FRAME REEL. REEL ONLY, HOSE SOLD SEPARATE</p>		<p>Call for Price</p>

Prices Subject to Change

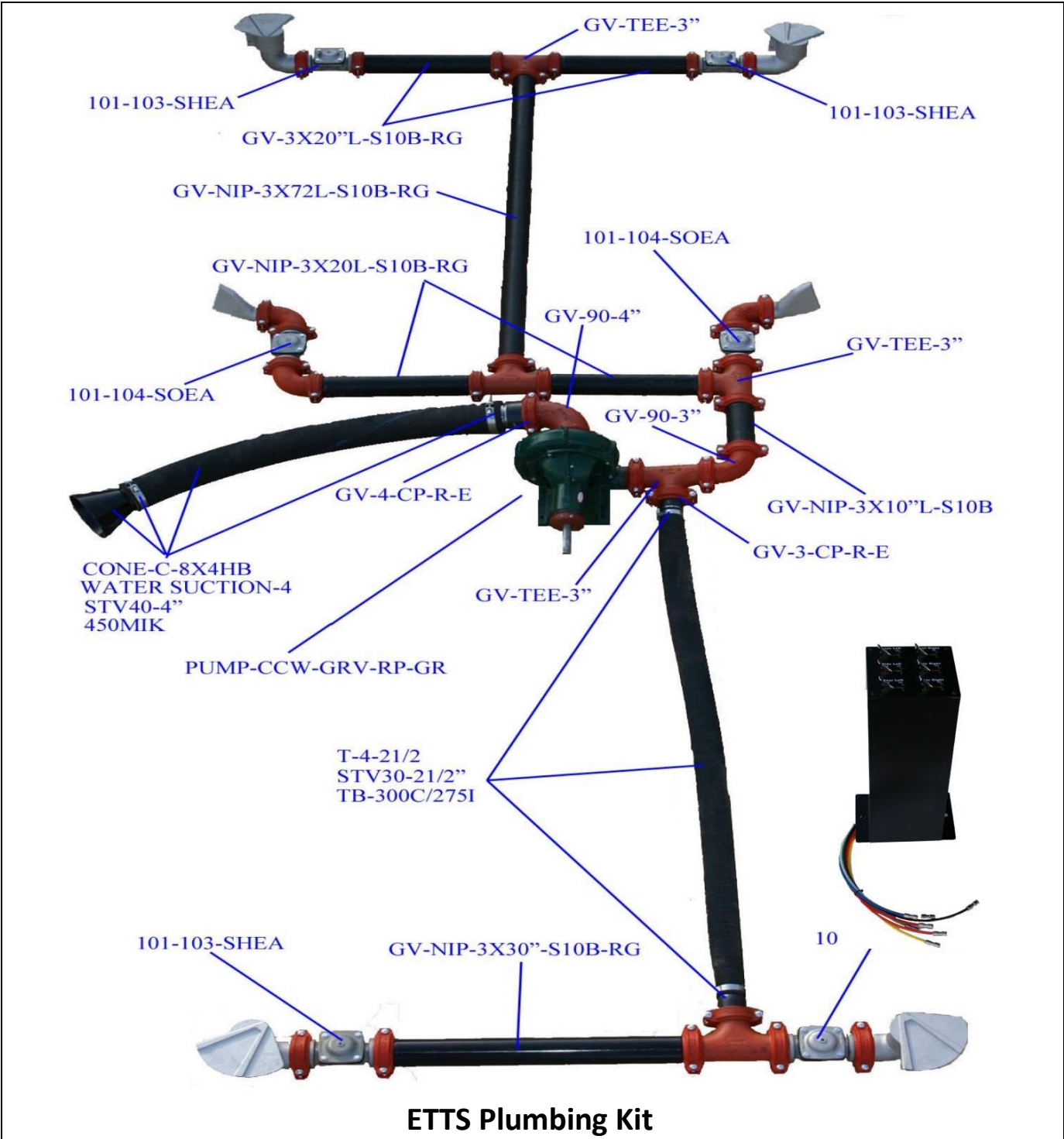

ETTS Plumbing Kit

RV-6 SPRAY-KIT-101 Plumbing kit with all groove connection, includes ALL pipe, pump, clamps, valves, hose, KWIK-E-TOWER, ect. Needed to install a 5 spray system on a water truck with 101 groove inline valves. (some minor adjustments may have to be done to quote to fit your truck)

SEE PICTURE ABOVE
(SOME ADJUSTMENTS MAY HAVE TO BE MADE TO FIT YOUR TURCK)

For Manual Transmission
\$5,250.00

For Automatic Transmission
\$6,170.00

About Us

East Texas Truck Systems was established as a water truck rig-up shop in 2006 by David Rhodes in Tyler, Texas. From then we've expanded our services to include dump trucks, flatbeds, vacuum trucks, etc. Our priority is to create a quality product that will best serve our customer's needs. Whether that customer is a municipality, small/large company, fire department, individual, or a dealership.

We sell parts, tanks, complete trucks, or we can install a system on your chassis. We are great at working with budgets. So give ETTS a call for any of your water truck needs.

ETTS

2283 Montgomery Gardens

Tyler, TX 75708

(903) 531-9700

www.easttexastrucksystems.com

sales@easttexastrucksystems.com



Connect with us!

